

Description

Damper actuator serie S32 to operate and position air dampers in HVAC systems.

- For air dampers up to approx. 6 m²
- Nominal voltage 24 Vac/dc and 100...240 Vac
- Control: Open-close or 3-point and proportional
- Characteristics: universal spindle clamp fo easy direct mounting, shaft dimensions Ø 10 to 20 mm round / □ 10 to 16 mm square, minimum shaft length 50 mm, anti-rotation bracket provided for stability, manual over ride by push button, selectable direction of rotation, adjustable angle of rotation, parallel connection up to 10 actuators.

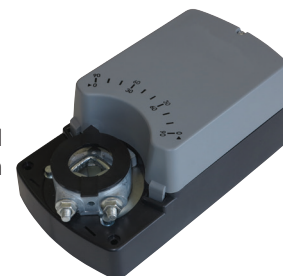

Technical features

Actuator model		S32A	S32B	S32AM	S32BM
Damper area	m ²			6	
Nominal torque	Nm			32	
Power supply	V	24 AC/DC	100...240 AC	24 AC/DC	100...240 AC
Frequency	Hz			50/60	
Power consumption					
- in operation	W			4,5	
- at rest	W	0,5	0,7	0,5	0,7
- for wire sizing	VA			7,0	
Running time	s			180	
Sound power level	db (A)			45	
Control signal		2-3 point	2-3 point	0(2)...10 V DC 0(4)...20 mA	0(2)...10 V DC 0(4)...20 mA
Auxiliary switch rating				3 (1,5) A, 230 V AC	
Life Cycle	cycles			60.000	
Rotation angle					
- operating				0-90°	
- limitation				5-85° (steps of 5°)	
Protection class		III	II	III	II
Protection degree				IP54	
Working range °C				-20...+70° C	
Working range RH				5...95% RH, non-condensating	
Storage temperature				-40...+80° C	
Maintenance				free	
Weight	g			1300	
Standards				CE-conformity, RoHs	
Option				suffix S for models with 2 SPDT auxiliary switches	



Electrical wirings for models at 2 / 3 points

Wiring diagram

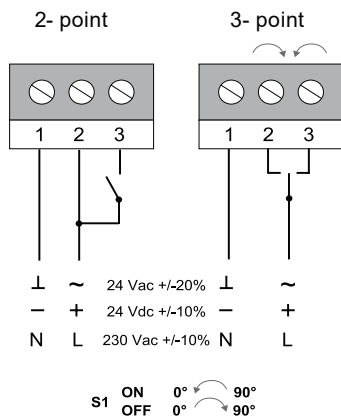

Auxiliary switches

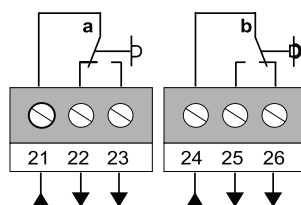

3 (1,5) A 230 Vac
actuator in position 0°

Parallel connections

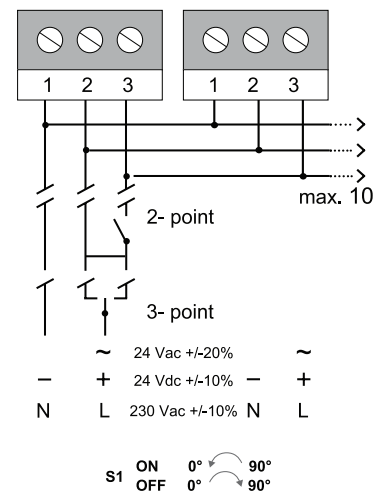

Electrical wirings for proportional models

Wiring diagram 230 V AC

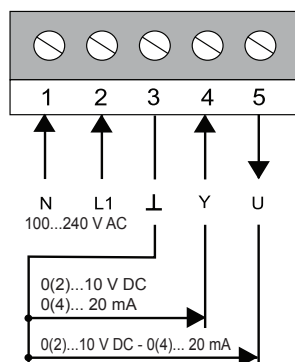

Wiring diagram 24 V AC

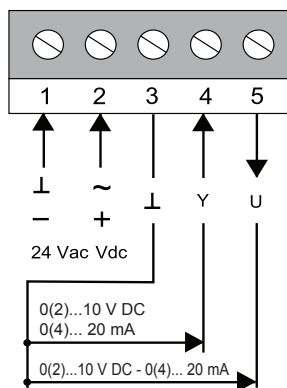

Auxiliary switches

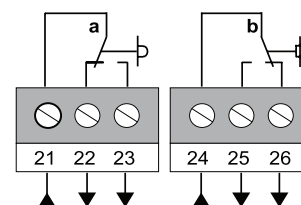

3 (1,5) A 230 Vac
actuator in position 0°

Settings DIP switches

DIP 1
Feedback signal



OFF: 0(2)...10 V
ON: 0(4)...20 mA

DIP 2
Input signal starting point



OFF: 0...10 V o 0...20 mA
ON: 2...10 V o 4...20 mA

DIP 3
Input signal



OFF: 0(2)...10 V
ON: 0(4)...20 mA

DIP 4
Rotation direction

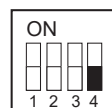

OFF: With the increase of the signal,
the actuator rotate counterclockwise
ON: With the increase of the signal,
the actuator rotate clockwise

S2
Rotation direction



option



Auxiliary switch adjustment

Factory setting:
switch a at 10°
switch b at 80°
The switching position can
be changed manually.

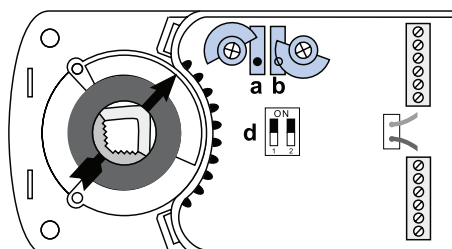

Angle of rotation limiting

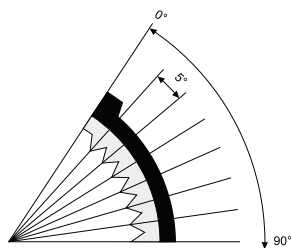

Adapter release

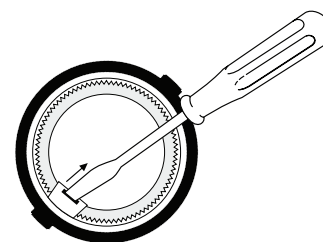

■ Dimensions (mm)

